

# Expand LinkWall examples

Height 220/290 cm

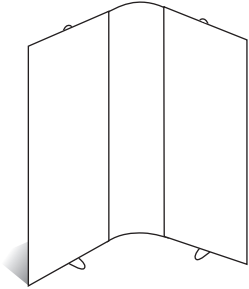

90+60+90

2 base units - 2 panels (90 cm)  
1 flex panel (60 cm)

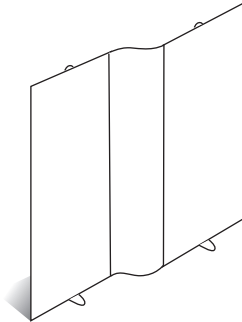

90+60+90

2 base units - 2 panels (90 cm)  
1 flex panel (60 cm)

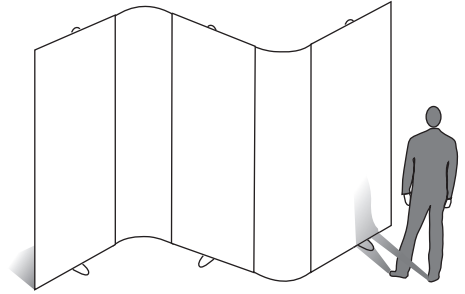

90+60+90+60+90

3 base units - 3 panels (90 cm)  
2 flex panels (60 cm)

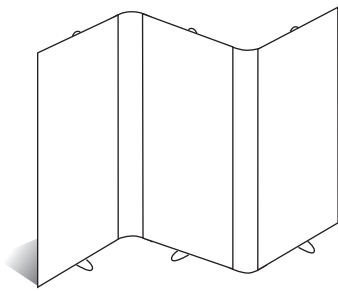

90+27+90+27+90

3 base units - 3 panels (90 cm)  
2 flex panels (27 cm)

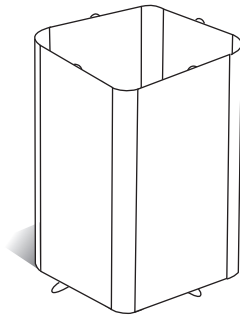

4 x (90+27)

4 base units - 4 panels (90 cm)  
4 flex panels (27 cm)

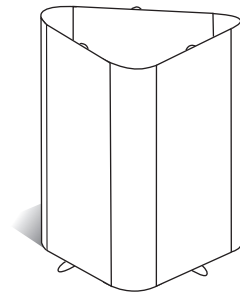

3 x (90+60)

3 base units - 3 panels (90 cm)  
3 flex panels (60 cm)

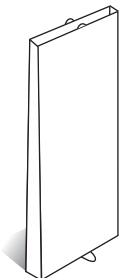

90+SP+90+EP

1 base unit - 2 panels (90 cm)  
2 end panels (EP)

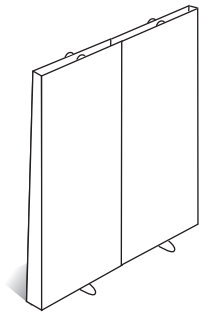

2 x (90+90+EP)

2 base units - 4 panels (90 cm)  
2 end panels (EP)

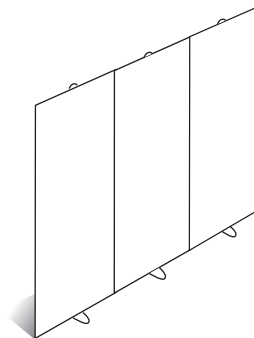

90+90+90

3 base units - 3 panels (90 cm)

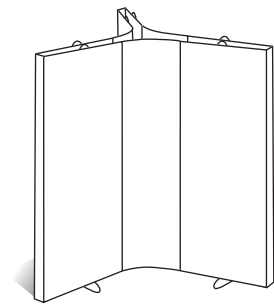

3x(90+60+90+EP)

3 base units - 6 panels (90 cm)  
3 flex panels (60 cm)  
3 end panels (EP)

Please note: only straight configurations can be made double-sided

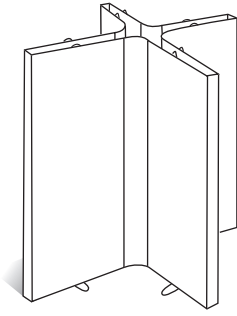

4x(90+27+90+EP)

4 base units - 8 panels (90 cm)  
4 flex panels (27 cm)  
4 end panels (EP)

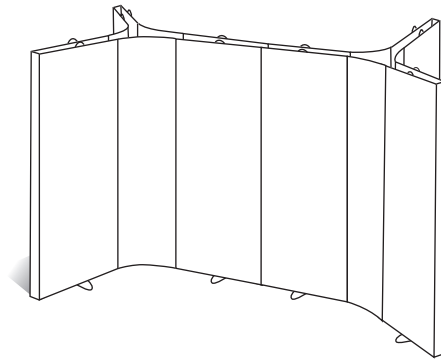

2x(90+60+90+90+60+90)  
2x(SP+90+60+90+EP)

6 base units - 12 panels (90 cm)  
6 flex panels (60 cm)  
4 end panels (EP)

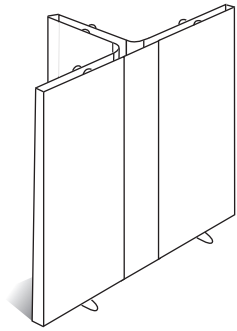

3x(90+27+90+SP)

3 base units - 6 panels (90 cm)  
3 flex panels (60 cm)  
3 end panels (EP)

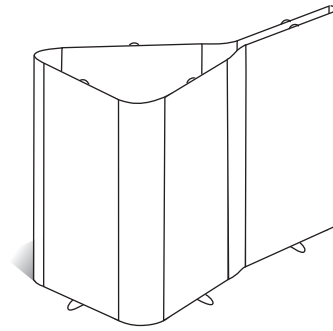

(90+60+90+60+90+60+90+60+90+SP)

4 base units - 5 panels (90 cm)  
4 flex panels (60 cm)  
1 end panel (EP)

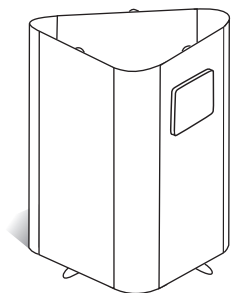

3 x (90+60)

3 base units - 3 panels (90 cm)  
3 flex panels (60 cm)  
1 Monitor -Expand LinkWall