



An extremely cost effective demonstrator unit that is lightweight, portable and simple to assemble.

Apply your promotional graphics as vinyls or screen print directly onto the plastic base wrap.

features & benefits

- Lightweight plastic, flat pack promotional unit
- Extremely cost effective
- Includes rigid header panel, shelf and twin supporting poles
- Supplied with carry bag

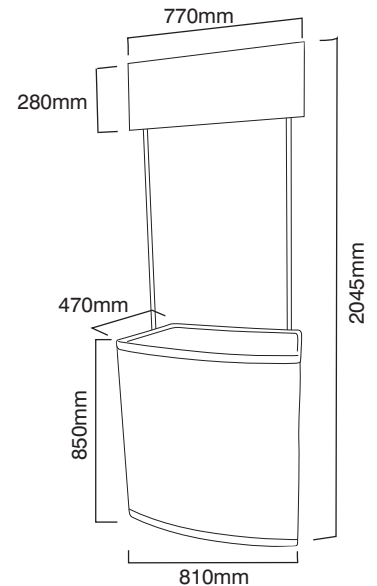
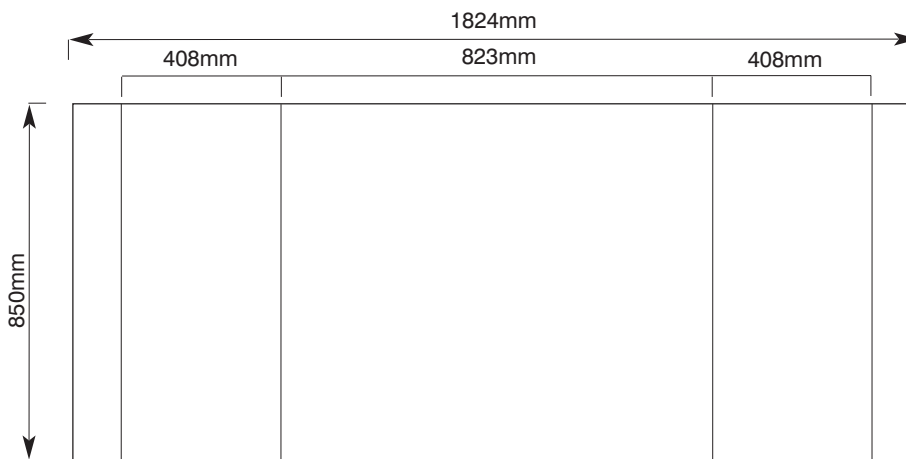

unit dimensions
(all approx)

hardware specifications

Hardware Dimensions (mm)
2045 (h) x 810 (w) x 470 (d) approx.

Base Dimensions (mm):
850 (h) x 810 (w) x 470 (d) approx.

Weight:
10g approx (inc carry bag)

graphic specifications

Recommended graphic dimensions
See above wrap layout

Header dimensions (mm):
280 (h) x 770 (w) approx.

additional info

Graphics may be screen printed directly onto the base wrap. Self adhesive vinyl graphics may also be mounted onto the base wrap and header.

Assembly Instructions

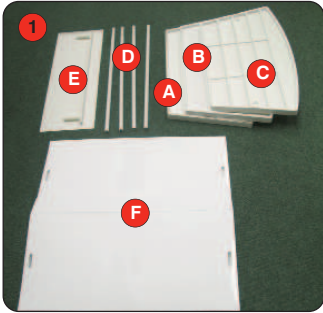

Kit includes: 1 x top (A), 1 x base (B), 1 x internal shelf (C), 4 x poles (D), 1 x header (E), 1 x wrap (F)

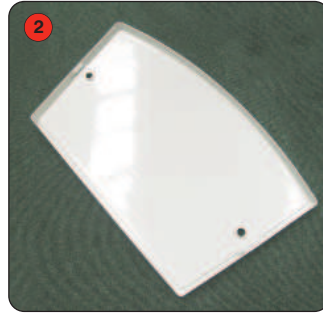

Take one of the two identical moulded top/base (A/B) units and place on floor raw edge facing upwards.



Unfold wrap (F) and slot into the base with opening on the shorter edge of the base.

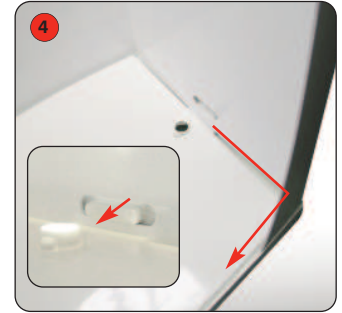

Slot the wrap securely into the base ensuring the pips on either side of the base push through the hole in either side of the wrap.



Take the shelf (C) and slide down through the top of the wrap.

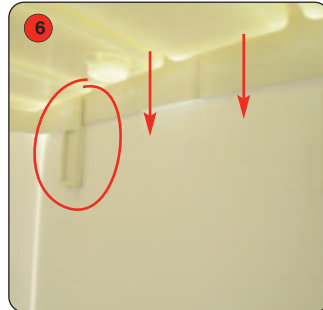

The shelf should slot in tightly into the grooves on the inside of the wrap.

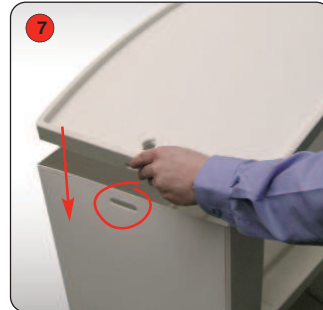

Take the 2nd moulded top/base (A/B) and slot over wrap, again ensuring pips push through wrap

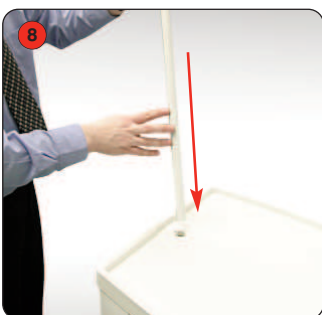

Slot one male pole (D) through the hole in top of unit, ensuring male end is to the outside.



Create header assembly by slotting two poles into the header.
(male ends into header)



Finally attach the the header assembly to the main unit.

